

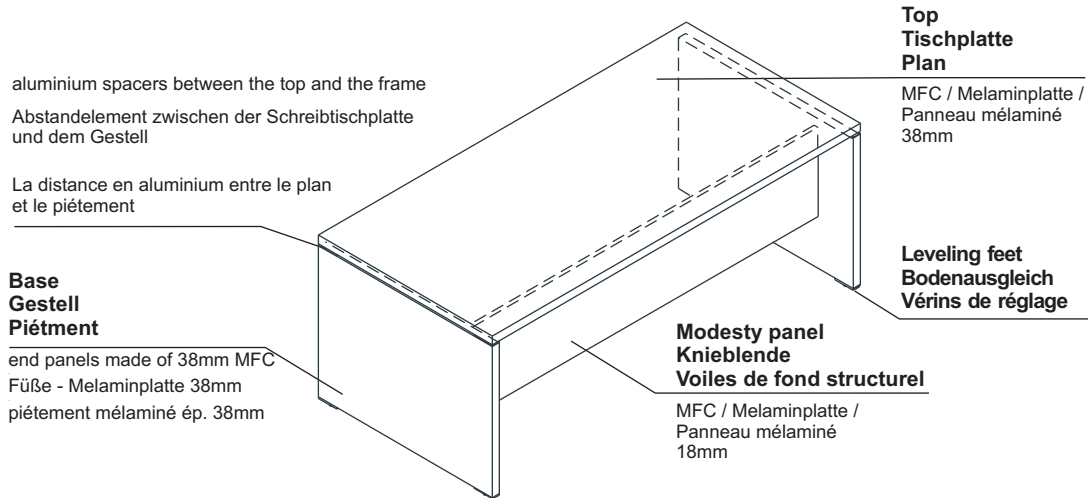

TECHNICAL SPECIFICATION / TECHNISCHE BESCHREIBUNG / DESCRIPTION TECHNIQUE

DESKS, TABLES / SCHREIBTISCHE, TISCHE / BUREAUX, TABLES



POSSIBLE CONFIGURATIONS / BEISPIEL ANORDNUNG / EXEMPLES DE CONFIGURATIONS

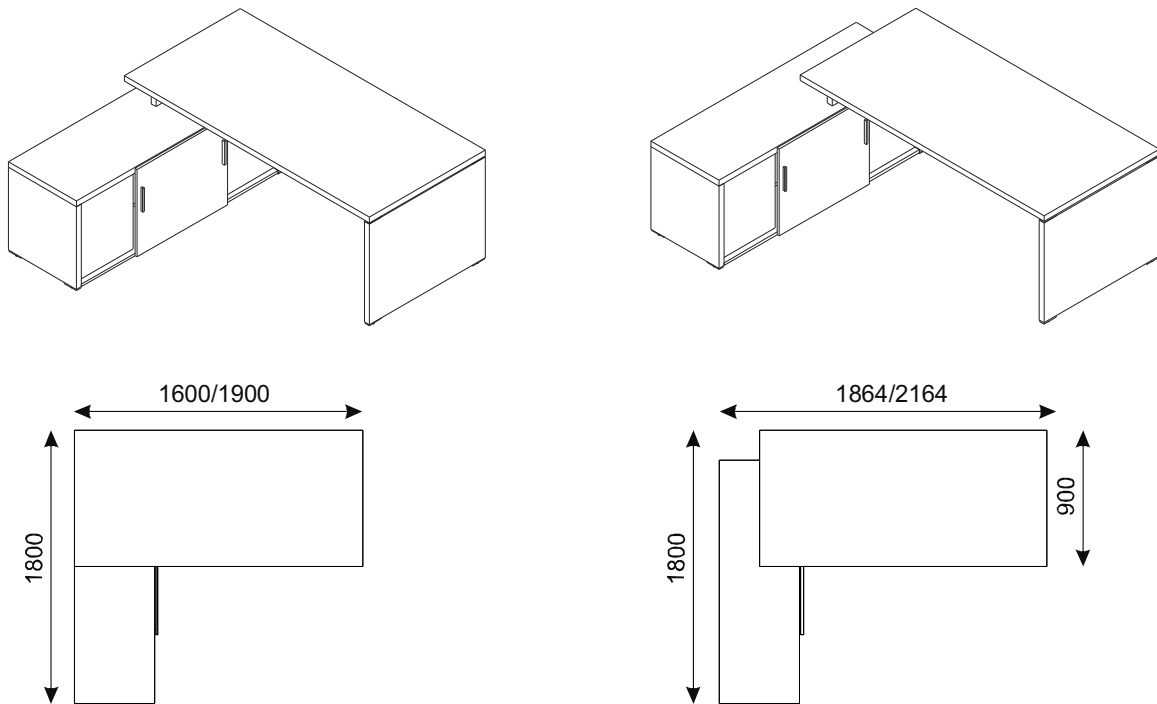

STORAGE / SIDEBORD / COMMODE

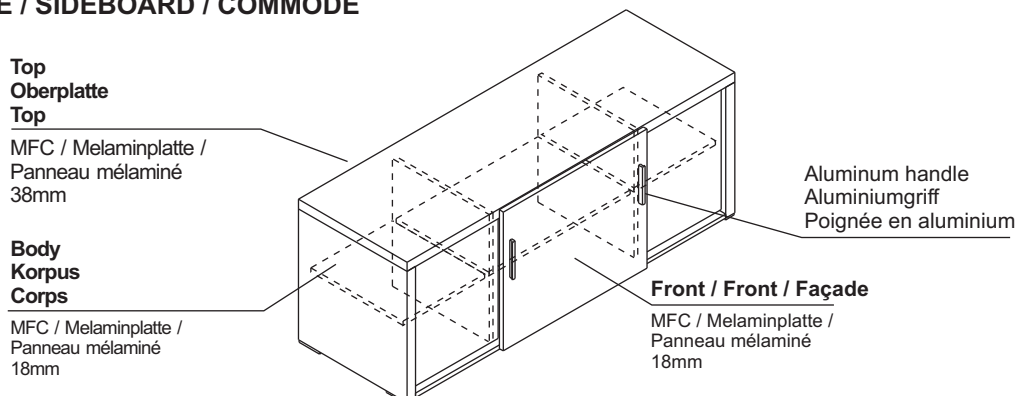



TECHNICAL SPECIFICATION / TECHNISCHE BESCHREIBUNG / DESCRIPTION TECHNIQUE

STORAGE / SCHRÄNKE / ARMOIRE

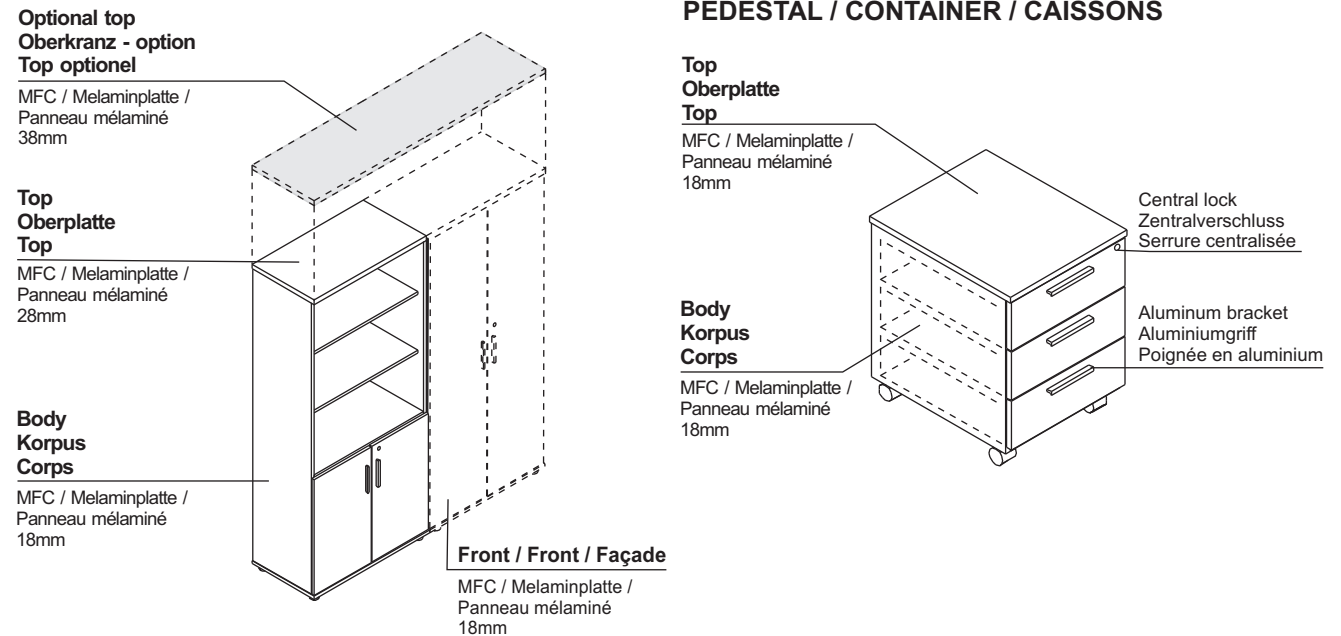
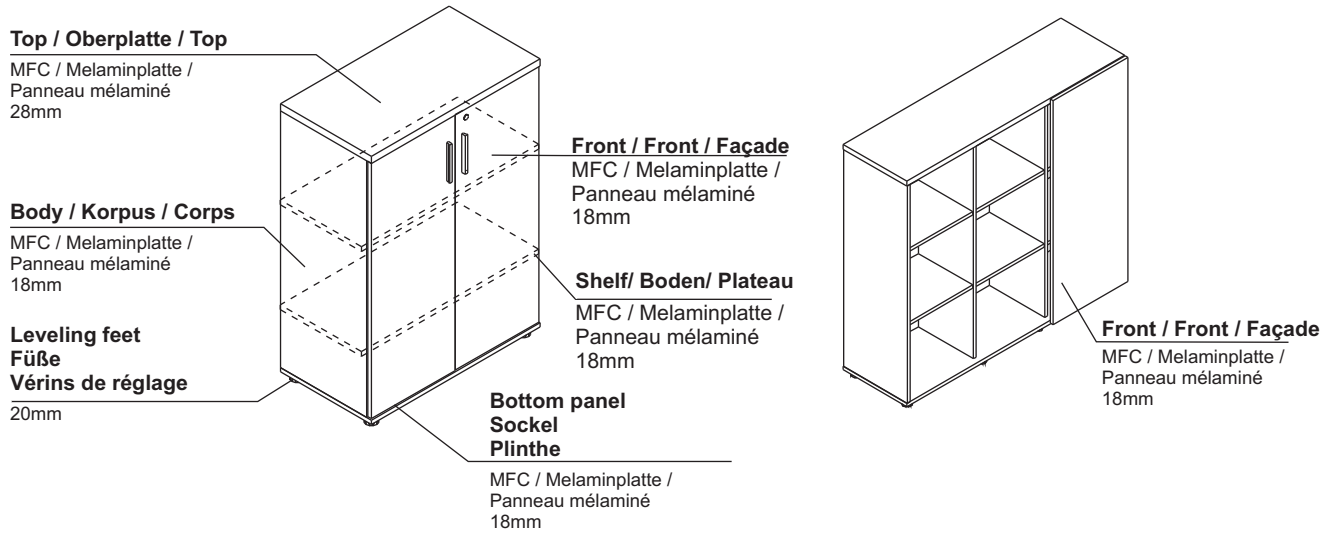

Optional top, applied to two or three cabinets.

Oberkranz als Option zu zwei oder drei Schränke

Top en option appliquée à deux ou trois armoires.



TECHNICAL SPECIFICATION / TECHNISCHE BESCHREIBUNG / DESCRIPTION TECHNIQUE

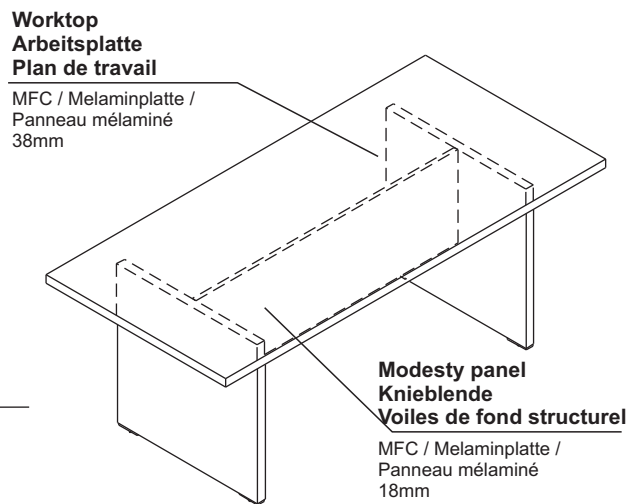
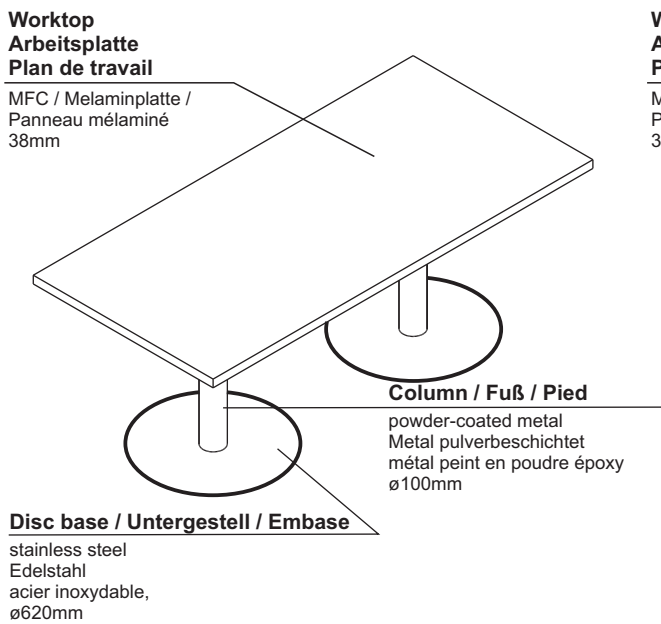
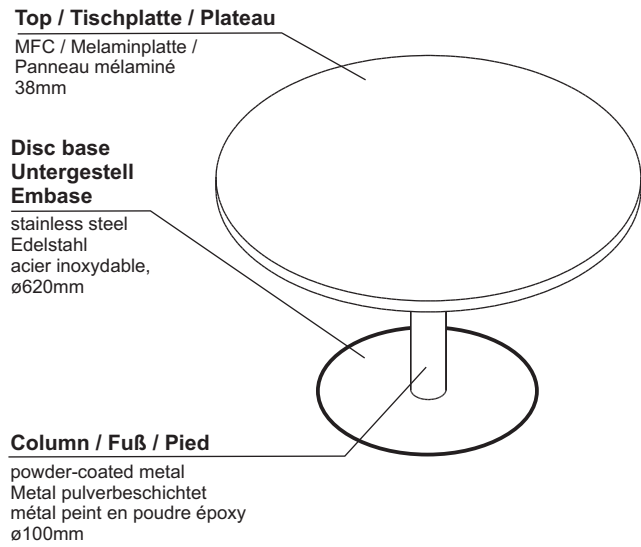
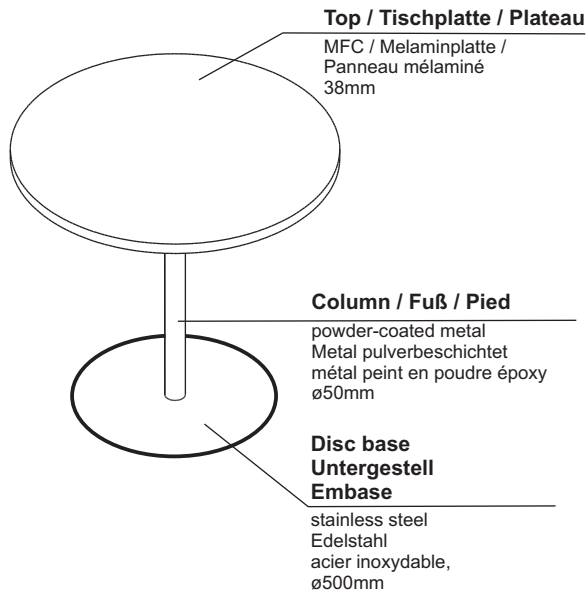

FINISHES / FARBEN / FINITIONS

31 CANADIAN OAK KANADISCHE EICHE CHENE CANADIEN	34 CHESTNUT WENGE	106 LOWLAND NUT NUSSBAUM PLAINE NOYER					
08 BLACK SCHWARZ NOIR	09 ALUMINIUM ALUMINIUM ALUMINIUM	15 METAL, HIGH GLOSS WHITE METALL, WEIß GLANZ METAL, BLANC BRILLANT					
STAINLESS STEEL EDELSTAHL ACIER INOXYDABLE							